

Data sheet | Item number: 236-723

Stackable PCB terminal block; 2.5 mm<sup>2</sup>; Pin spacing 7.5/7.62 mm; 1-pole;  
CAGE CLAMP®; commoning option



236-723



RoHS  
Compliant



Color: ■

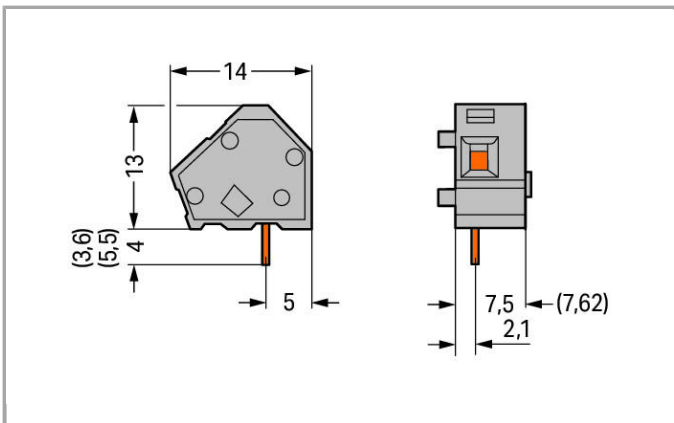
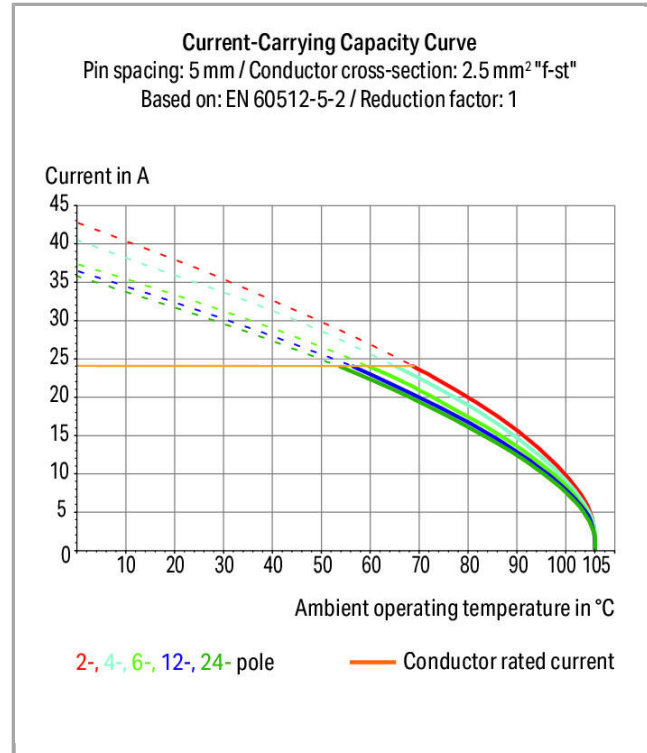

Item description



- Modular PCB terminal blocks with CAGE CLAMP® connection, screwdriver actuation parallel or perpendicular to conductor entry
- Versions with Ex approval
- For custom PCB terminal strip assemblies
- 45° conductor entry angle permits a wide range of applications and wiring options
- Set to metric or inch pin spacing by compressing PCB terminal strips or pulling them apart

## Data

### Electrical data

#### Ratings per IEC/EN 60664-1

Rated voltage (III / 3)	400 V
Rated impulse voltage (III / 3)	6 kV
Rated voltage (III / 2)	630 V
Rated impulse voltage (III / 2)	6 kV
Rated voltage (II / 2)	1000 V
Rated impulse voltage (II / 2)	6 kV
Rated current	24 A

#### Approvals per UL 1059

Rated voltage UL (Use Group B)	300 V
Rated current UL (Use Group B)	15 A
Rated voltage UL (Use Group D)	300 V
Rated current UL (Use Group D)	10 A

#### Approvals per CSA

Rated voltage CSA (Use Group B)	300 V
Rated current CSA (Use Group B)	15 A
Rated voltage CSA (Use Group D)	300 V
Rated current CSA (Use Group D)	10 A

### Connection data

Connection technology	CAGE CLAMP®
Actuation type	Operating tool
Solid conductor	0.08 ... 2.5 mm <sup>2</sup> / 28 ... 12 AWG
Fine-stranded conductor	0.08 ... 2.5 mm <sup>2</sup> / 28 ... 12 AWG
Fine-stranded conductor with ferrule with plastic collar	0.25 ... 1.5 mm <sup>2</sup>
Fine-stranded conductor with ferrule without plastic collar	0.25 ... 1.5 mm <sup>2</sup>
Strip length	5 ... 6 mm / 0.2 ... 0.24 inch
Conductor entry angle to the PCB	45°

Note (conductor cross-section)	12 AWG: THHN, THWN
No. of poles	1
Total number of connection points	1
Total number of potentials	1
Number of connection types	1
Number of levels	1

### Geometrical Data

Pin spacing	7.5/7.62 mm / 0.295/0.3 inch
Width	9.7 mm / 0.382 inch
Height	17 mm / 0.669 inch
Height from the surface	13 mm / 0.512 inch
Depth	14 mm / 0.551 inch
Solder pin length	4 mm
Solder pin dimensions	0.7 x 0.7 mm
Drilled hole diameter (tolerance)	1.1 <sup>(- ... +0.1)</sup> mm

### PCB contact

PCB contact	THT
Solder pin arrangement	over the entire terminal strip, in line
Number of solder pins per potential	1

### Material Data

Color	light gray
Material group	I
Insulating material	Polyamide 66 (PA 66)
Flammability class per UL94	V0
Clamping spring material	Chrome nickel spring steel (CrNi)
Contact material	Electrolytic copper (E <sub>Cu</sub> )
Contact plating	tin-plated
Fire load	0.018 MJ
Weight	1.055 g

### Environmental Requirements

Limit temperature range	-60 ... +105 °C
-------------------------	-----------------





### Commercial data

Product Group	4 (Printed Circuit)
Country of origin	CH

GTIN	4044918773980
Customs Tariff No.	85369010000

## Approvals / Certificates

### Country specific Approvals

Logo	Approval	Additional Approval Text	Certificate name
	CCA DEKRA Certification B.V.	EN 60998	NTR NL-7195
	CCA DEKRA Certification B.V.	EN 60947	2168090.01
	CCA DEKRA Certification B.V.	EN 60947	NTR NL-7109
	CSA DEKRA Certification B.V.	C22.2 No. 158	1673957

### Ship Approvals



Logo	Approval	Additional Approval Text	Certificate name
	DNV GL Det Norske Veritas, Germanischer Lloyd	-	TAE000016Z

### UL-Approvals





Logo	Approval	Additional Approval Text	Certificate name
	UR Underwriters Laboratories Inc.	UL 1059	E45172, sec. 6

### Compatible products









## check

	<b>Item no.: 231-125</b> Testing plug module with contact stud; Pin spacing 7.62 mm / 0.3 in	231-125
	<b>Item no.: 231-161</b> Testing plug module with contact stud; for 236 Series; Pin spacing 7.5 mm / 0.295 in	231-161

## tools

	<b>Item no.: 210-657</b> Operating tool with partially insulated shaft; Blade (3.5 x 0.5) mm; short	210-657
	<b>Item no.: 210-658</b> Operating tool with partially insulated shaft; Blade (3.5 x 0.5) mm; short; angled	210-658
	<b>Item no.: 210-720</b> Operating tool with partially insulated shaft; Type 2, blade (3.5 x 0.5) mm	210-720
	<b>Item no.: 236-332</b> Operating tool; Plastic	236-332
	<b>Item no.: 236-335</b> Operating tool; metal	236-335

## End plate

	<b>Item no.: 236-100</b> End plate; 1 mm thick; snap-fit type	236-100
	<b>Item no.: 236-200</b> End plate; 1 mm thick; snap-fit type	236-200
	<b>Item no.: 236-300</b> End plate; 1 mm thick; snap-fit type	236-300
	<b>Item no.: 236-400</b> End plate; 1 mm thick; snap-fit type	236-400
	<b>Item no.: 236-500</b> End plate; 1 mm thick; snap-fit type	236-500
	<b>Item no.: 236-600</b> End plate; 1 mm thick; snap-fit type	236-600
	<b>Item no.: 236-700</b> End plate; 1 mm thick; snap-fit type	236-700
	<b>Item no.: 236-800</b> End plate	236-800
	<b>Item no.: 236-850</b> End plate; 1 mm thick; snap-fit type	236-850

















## Marking accessories

















<b>Item no.: 210-332/750-020</b> Marking strips; as a DIN A4 sheet; MARKED; 1-20 (80x); Height of marker strip: 3 mm; Strip length 182 mm; Horizontal marking; Self-adhesive	210-332 // 50-020
<b>Item no.: 210-332/762-020</b> Marking strips; as a DIN A4 sheet; MARKED; 1-20 (80x); Height of marker strip: 3 mm; Strip length 182	

mm; Horizontal marking; Self-adhesive

210-332

// 62-U2U

ferrule		
	<b>Item no.: 216-101</b> Ferrule; Sleeve for 0.5 mm <sup>2</sup> / AWG 22; uninsulated; electro-tin plated	216-101
	<b>Item no.: 216-102</b> Ferrule; Sleeve for 0.75 mm <sup>2</sup> / AWG 20; uninsulated; electro-tin plated	216-102
	<b>Item no.: 216-103</b> Ferrule; Sleeve for 1 mm <sup>2</sup> / AWG 18; uninsulated; electro-tin plated	216-103
	<b>Item no.: 216-104</b> Ferrule; Sleeve for 1.5 mm <sup>2</sup> / AWG 16; uninsulated; electro-tin plated	216-104
	<b>Item no.: 216-121</b> Ferrule; Sleeve for 0.5 mm <sup>2</sup> / AWG 22; uninsulated; electro-tin plated	216-121
	<b>Item no.: 216-122</b> Ferrule; Sleeve for 0.75 mm <sup>2</sup> / AWG 20; uninsulated; electro-tin plated	216-122
	<b>Item no.: 216-123</b> Ferrule; Sleeve for 1 mm <sup>2</sup> / AWG 18; uninsulated; electro-tin plated	216-123
	<b>Item no.: 216-124</b> Ferrule; Sleeve for 1.5 mm <sup>2</sup> / AWG 16; uninsulated; electro-tin plated	216-124
	<b>Item no.: 216-131</b> Ferrule; Sleeve for 0.25 mm <sup>2</sup> / AWG 24; uninsulated; electro-tin plated	216-131
	<b>Item no.: 216-132</b> Ferrule; Sleeve for 0.34 mm <sup>2</sup> / AWG 24; uninsulated; electro-tin plated	216-132
	<b>Item no.: 216-141</b> Ferrule; Sleeve for 0.5 mm <sup>2</sup> / 20 AWG; uninsulated; electro-tin plated; electrolytic copper; gastight crimped; acc. to DIN 46228, Part 1/08.92	216-141
	<b>Item no.: 216-142</b> Ferrule; Sleeve for 0.75 mm <sup>2</sup> / 18 AWG; uninsulated; electro-tin plated; electrolytic copper; gastight crimped; acc. to DIN 46228, Part 1/08.92	216-142
	<b>Item no.: 216-143</b> Ferrule; Sleeve for 1 mm <sup>2</sup> / AWG 18; uninsulated; electro-tin plated; electrolytic copper; gastight crimped; acc. to DIN 46228, Part 1/08.92	216-143
	<b>Item no.: 216-144</b> Ferrule; Sleeve for 1.5 mm <sup>2</sup> / AWG 16; uninsulated; electro-tin plated; electrolytic copper; gastight crimped; acc. to DIN 46228, Part 1/08.92	216-144
	<b>Item no.: 216-151</b> Ferrule; Sleeve for 0.25 mm <sup>2</sup> / AWG 24; uninsulated; electro-tin plated	216-151
	<b>Item no.: 216-152</b> Ferrule; Sleeve for 0.34 mm <sup>2</sup> / AWG 24; uninsulated; electro-tin plated	216-152
	<b>Item no.: 216-201</b> Ferrule; Sleeve for 0.5 mm <sup>2</sup> / 20 AWG; insulated; electro-tin plated	216-201
	<b>Item no.: 216-202</b>	

	Ferrule; Sleeve for 0.75 mm <sup>2</sup> / 18 AWG; insulated; electro-tin plated	216-202
	<b>Item no.: 216-203</b> Ferrule; Sleeve for 1 mm <sup>2</sup> / AWG 18; insulated; electro-tin plated	216-203
	<b>Item no.: 216-204</b> Ferrule; Sleeve for 1.5 mm <sup>2</sup> / AWG 16; insulated; electro-tin plated	216-204
	<b>Item no.: 216-221</b> Ferrule; Sleeve for 0.5 mm <sup>2</sup> / 20 AWG; insulated; electro-tin plated	216-221
	<b>Item no.: 216-222</b> Ferrule; Sleeve for 0.75 mm <sup>2</sup> / 18 AWG; insulated; electro-tin plated	216-222
	<b>Item no.: 216-223</b> Ferrule; Sleeve for 1 mm <sup>2</sup> / AWG 18; insulated; electro-tin plated	216-223
	<b>Item no.: 216-224</b> Ferrule; Sleeve for 1.5 mm <sup>2</sup> / AWG 16; insulated; electro-tin plated	216-224
	<b>Item no.: 216-241</b> Ferrule; Sleeve for 0.5 mm <sup>2</sup> / 20 AWG; insulated; electro-tin plated; electrolytic copper; gastight crimped; acc. to DIN 46228, Part 4/09.90	216-241
	<b>Item no.: 216-242</b> Ferrule; Sleeve for 0.75 mm <sup>2</sup> / 18 AWG; insulated; electro-tin plated; electrolytic copper; gastight crimped; acc. to DIN 46228, Part 4/09.90	216-242
	<b>Item no.: 216-243</b> Ferrule; Sleeve for 1 mm <sup>2</sup> / AWG 18; insulated; electro-tin plated; electrolytic copper; gastight crimped; acc. to DIN 46228, Part 4/09.90	216-243
	<b>Item no.: 216-244</b> Ferrule; Sleeve for 1.5 mm <sup>2</sup> / AWG 16; insulated; electro-tin plated; electrolytic copper; gastight crimped; acc. to DIN 46228, Part 4/09.90	216-244
	<b>Item no.: 216-262</b> Ferrule; Sleeve for 0.75 mm <sup>2</sup> / 18 AWG; insulated; electro-tin plated; electrolytic copper; gastight crimped; acc. to DIN 46228, Part 4/09.90	216-262
	<b>Item no.: 216-263</b> Ferrule; Sleeve for 1 mm <sup>2</sup> / AWG 18; insulated; electro-tin plated; electrolytic copper; gastight crimped; acc. to DIN 46228, Part 4/09.90	216-263
	<b>Item no.: 216-264</b> Ferrule; Sleeve for 1.5 mm <sup>2</sup> / AWG 16; insulated; electro-tin plated; electrolytic copper; gastight crimped; acc. to DIN 46228, Part 4/09.90	216-264
	<b>Item no.: 216-284</b> Ferrule; Sleeve for 1.5 mm <sup>2</sup> / AWG 16; insulated; electro-tin plated; electrolytic copper; gastight crimped; acc. to DIN 46228, Part 4/09.90	216-284
	<b>Item no.: 216-301</b> Ferrule; Sleeve for 0.25 mm <sup>2</sup> / AWG 24; insulated; electro-tin plated	216-301
	<b>Item no.: 216-302</b> Ferrule; Sleeve for 0.34 mm <sup>2</sup> / 22 AWG; insulated; electro-tin plated	216-302
	<b>Item no.: 216-321</b> Ferrule; Sleeve for 0.25 mm <sup>2</sup> / AWG 24; insulated; electro-tin plated	216-321
	<b>Item no.: 216-322</b> Ferrule; Sleeve for 0.34 mm <sup>2</sup> / 22 AWG; insulated; electro-tin plated	216-322



---

**Downloads****CAD/CAE - Smart Data****CAD data**

3D Download 236-723		URL	Download
<b>PCB libraries</b>			
EAGLE Library for WAGO PCB Terminal Blocks Compatible with EAGLE PCB Design Software Version 6.x or higher	2.1 Oct 6, 2014	zip 23.9 MB	Download
TARGET Library for WAGO PCB Terminal Blocks Compatible with TARGET PCB Design Software Version 17.x	1.1.0 Oct 6, 2014	zip 27.1 MB	Download
DesignSpark Library for WAGO PCB Terminal Blocks Compatible with DesignSpark PCB Version 4.x or higher	2.1 Oct 6, 2014	zip 22.5 MB	Download

Subject to changes.

---